

# Saturated Absorption Spectroscopy

(Based on Teachspin manual)

## 1 Background

One of the most important scientific applications of lasers is in the area of precision atomic and molecular spectroscopy. Spectroscopy is used not only to better understand the structure of atoms and molecules, but also to define standards in metrology. For example, the second is defined from atomic clocks using the 9192631770 Hz (exact, by definition) hyperfine transition frequency in atomic cesium, and the meter is (indirectly) defined from the wavelength of lasers locked to atomic reference lines. Furthermore, precision spectroscopy of atomic hydrogen and positronium is currently being pursued as a means of more accurately testing quantum electrodynamics (QED), which so far is in agreement with fundamental measurements to a high level of precision (theory and experiment agree to better than a part in  $10^8$ ). Ref. (Hänsch 1979) is an excellent article describing precision spectroscopy of atomic hydrogen, the simplest atom.

Important concepts: Doppler broadening and velocity class; natural linewidth; spin-orbit coupling.

### Saturated Absorption Spectroscopy: 2-level atoms

Saturated absorption spectroscopy is one simple and frequently-used technique for measuring narrow-line atomic spectral features, limited only by the natural linewidth  $\Gamma$  of the transition (for the rubidium D lines  $\Gamma \approx 6$  MHz), from an atomic vapor with large Doppler broadening of  $\Delta\nu_{Dopp} \sim 1$  GHz. To see how saturated absorption spectroscopy works, consider the experimental set-up shown in Figure 1. Two lasers are sent through an atomic vapor cell from opposite directions; one, the “probe” beam, is very weak, while the other, the “pump” beam, is strong. Both beams are derived from the same laser, and therefore have the same frequency. As the laser frequency is scanned, the probe beam intensity is measured by a photodiode. If the probe frequency  $\nu$  coincides with the atomic resonance  $\nu_0$ , atoms will absorb light going from the ground state  $|g\rangle$  to the excited state  $|e\rangle$  (see Fig. 2(a)) resulting in probe absorption around the atomic resonance.

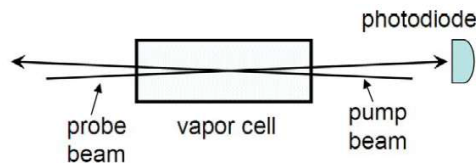

Figure 1: The basic saturated absorption spectroscopy setup.

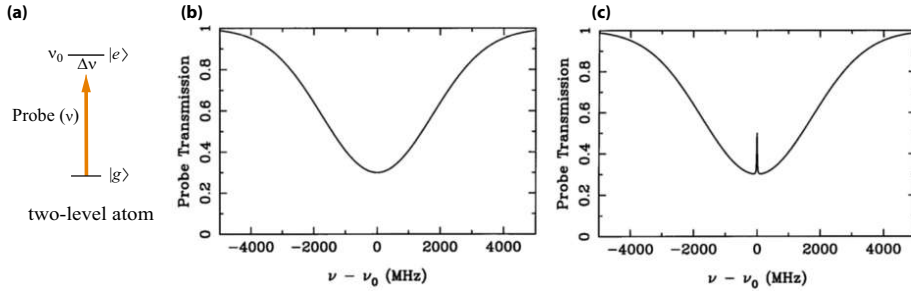

Figure 2: Probe absorption spectra for 2-level atoms (a), both without (b) and with (c) the pump beam.

If one had 2-level atoms in the vapor cell, one might record spectra like those shown in Figure 2. Fig. 2(b) gives the probe beam absorption without the pump beam. Here one sees simple Doppler-broadened absorption<sup>1</sup>; in our case the Doppler width is much larger than the natural linewidth,  $\Delta\nu_{Dopp} \gg \Gamma$ , and the optical depth of the vapor is fairly small  $\tau(\nu) \leq 1$  (the transmitted fraction of the probe is  $e^{-\tau(\nu)}$ , which defines the optical depth;  $\tau$  is proportional to the atomic vapor density and the path length), so the probe spectrum is essentially a simple Gaussian profile.

Fig. 2(c) shows the spectrum with the pump beam, showing an additional spike right at the atomic resonance frequency. The reason this spike appears is as follows: If the laser frequency is  $\nu_0 - \Delta\nu$ , with  $\nu_0$  the atomic resonant frequency, then the probe beam is absorbed only by atoms moving with longitudinal velocity  $v \approx c\Delta\nu/\nu_0$ , moving toward the probe beam. These atoms see the probe beam blueshifted into resonance; other atoms are not in resonance with the probe beam, and so they do not contribute to the probe absorption. These same atoms see the pump beam red-shifted further from resonance (since the pump beam is in the opposite direction) so they are unaffected by the pump beam. Thus for laser frequencies  $\nu \neq \nu_0$ , the probe absorption is the same with or without the pump beam. However if  $\nu = \nu_0$ , then atoms with  $v = 0$  contribute to the probe absorption. These  $v = 0$  atoms also see an on-resonance pump beam, which is strong enough to keep a significant fraction of the atoms in the excited state, where they do not absorb the probe beam (in fact they increase the probe beam intensity via stimulated emission). Thus at  $\nu = \nu_0$  the probe absorption is *less* than it was without the pump beam. (If the pump beam had infinite intensity, half of the atoms would be in the excited state at any given time, and there would be identically zero probe absorption. One would say these atoms were completely “saturated” by the pump beam, hence the name saturated absorption spectroscopy.) The advantage of this form of spectroscopy is that one can measure sharp Doppler-free features in a Doppler-broadened vapor.

### Saturated Absorption Spectroscopy: Multi-level atoms

If the atoms in the absorption cell had a single ground state and two excited states (typically an electronic level split by the hyperfine interaction), and the separation of the excited states was less than the Doppler width, then one would see a spectrum like that shown in Figure 3 (left). The peaks on the left and right are ordinary saturated absorption peaks at  $\nu_1$  and  $\nu_2$ , the two resonance

<sup>1</sup>The Doppler effect states that atoms moving towards (away from) a light source see the light frequency blue (red) shifted, so that atoms with different velocities absorb light at different frequencies. In a thermal vapor atoms move with velocities following the Maxwell-Boltzmann distribution, which produces broadening in the absorption profile.

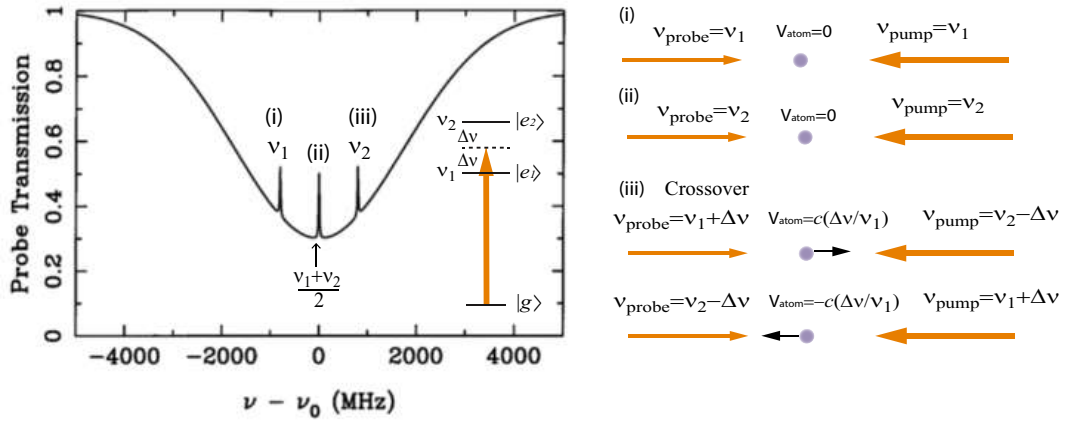

Figure 3: Saturated absorption spectrum for atoms with (left) a single ground state and two closely spaced excited states (right) schematic of situations giving rise to two saturated absorption peaks and one crossover peak.

frequencies. The middle peak at  $(\nu_1 + \nu_2)/2$  is called a “cross-over resonance.” If you think about it for a while you can see where the extra peak comes from. It arises from atoms moving at velocities such that the pump is in resonance with one transition, and the probe is in resonance with the other transition, as shown in Fig.3 (iii) right. If you think about it a bit more you will see there are two velocity classes of atoms for which this is true atoms moving toward the pump laser, and away from it.

### Atomic Structure of Rubidium

The structure of the atomic energy levels in rubidium is due to the interaction between its nuclear spin ( $I$ ) and the outer-most electron’s total angular momentum ( $J=L+S$ ), and is called hyperfine structure. The ground-state electronic configuration of rubidium consists of closed shells plus a single  $5s$  valence electron. This gives a spectrum which is similar to hydrogen (see Ref. (Hänsch 1979)). For the first excited state the  $5s$  electron is moved up to  $5p$ . Rubidium has two stable isotopes:  $^{85}\text{Rb}$  (72% abundance), with nuclear spin quantum number  $I = 5/2$ , and  $^{87}\text{Rb}$  (28% abundance), with  $I = 3/2$ .

The different energy levels are labeled by “term states”, with the notation  $^{2S+1}L'_J$ , where  $S$  is the spin quantum number,  $L'$  is the spectroscopic notation for the angular momentum quantum number (i. e.  $S, P, D, \dots$ , for orbital angular momentum quantum number  $L = 0, 1, 2, \dots$ ), and  $J = L + S$  is the total angular momentum quantum number. For the ground state of rubidium  $S = 1/2$  (since only a single electron contributes), and  $L = 0$ , giving  $J = 0 + 1/2 = 1/2$  and the ground state  $^2S_{1/2}$ . For the first excited state we have  $S = 1/2$ , and  $L = 1$ , giving  $J = 1/2$  or  $J = 3/2$ , so there are two excited states  $^2P_{1/2}$  and  $^2P_{3/2}$ . Spin-orbit (S-L) coupling lifts splits the otherwise degenerate  $P_{1/2}$  and  $P_{3/2}$  levels, as shown in Fig. 5.

The dominant term in the interaction between the nuclear spin and the electron gives rise to the magnetic hyperfine splitting [2]. The form of the interaction term in the atomic Hamiltonian is  $H_{hyp} \propto J \cdot I$ , which results in an energy splitting

$$\Delta E = \frac{C}{2}[F(F+1) - I(I+1) - J(J+1)]$$

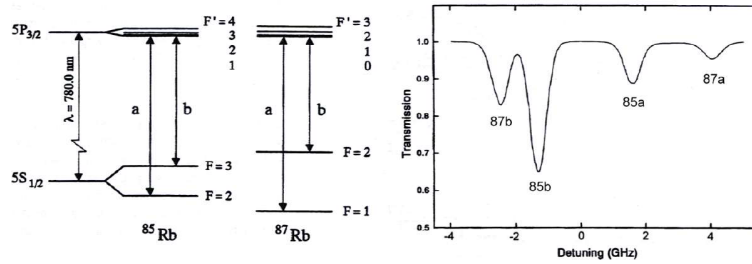

Figure 4: (Left) Level diagrams for the D2 lines of the two stable rubidium isotopes. (Right) Typical absorption spectrum for a rubidium vapor cell, with the different lines shown.

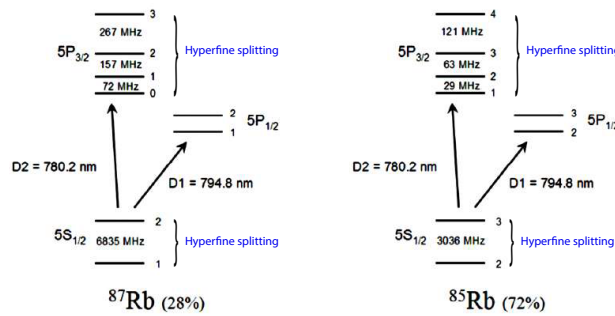

Figure 5: More rubidium level diagrams, showing the hyperfine splittings of the ground and excited states.

where  $F = I + J$  is the total angular momentum quantum number including nuclear spin, and  $C$  is the “hyperfine structure constant.” Figures 4 and 5 shows the lower  $S$  and  $P$  energy levels for  $^{85}\text{Rb}$  and  $^{87}\text{Rb}$ , including the hyperfine splitting.

## 2 Experimental procedure

The goal of this section is first to observe and record saturated absorption spectra for as many of the rubidium lines as you can, and then to see how well you can measure the  $P_{3/2}$  hyperfine splitting of  $^{85}\text{Rb}$  and  $^{87}\text{Rb}$  using a auxiliary interferometer as a length standard. Remember that eye safety is important. The laser operates at 780 nm, which is very close to being invisible. Thus you can shine a beam into your eye without noticing it. The laser power is about 20 mW, and all that power is concentrated in a narrow beam. Looking directly at the Sun puts about 1 mW into your eye, and that much power is obviously painful. It is possible to cause permanent eye damage using the Ph76 laser if you are not careful. Therefore be careful. ALWAYS WEAR LASER GOGGLES WHEN THE LASER IS ON! As long as you keep the goggles on, your eyes will be protected.

### Resonant absorption and laser tuning.

The first step is to get the laser turned on and tuned to hit the rubidium lines. We see in Figure 4 that the lines span about 8 GHz, which can be compared with the laser frequency of  $\nu = c/\lambda =$

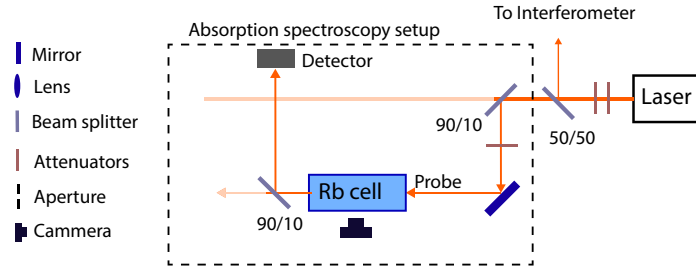

Figure 6: Recommended set-up to get the laser running on the rubidium resonance lines. This setup is the starting point for studying saturated spectroscopy with setup described in Fig. 7.

$4 \times 10^{14}$  Hz. Thus to excite the atoms at all the laser frequency must be tuned to about a part in  $10^5$ . Start with the simple set-up shown in Figure 6. The ND filter (attenuator) can be removed when aligning the laser beam.

Once you have the beam going about where you want it, sweep the high-voltage going to the grating PZT with a triangle wave, so that the voltage varies from about 0 to 100 volts, but keep the scan frequency of the RAMP generator  $\leq 10$  Hz. Use the HV/100 “MONITOR” output to monitor the high voltage on the oscilloscope. Sweeping this voltage sweeps the grating position using a small piezoelectric actuator (PZT). A good starting value of the knob of the coarse DC offset of the PZT controller can be about 4.5. While the high voltage is scanning you should then also change the laser injection current up and down by hand explore the full range. The current makes large changes in the laser frequency, while the PZT makes small changes (see the laser primer for details). The plan is that with all this sweeping the laser will sweep over the rubidium lines and you will see some fluorescence inside the vapor cell. You can use the camera to look at the fluorescence in the cell through the aperture in the cell enclosing. This will appear as a bright line inside the cell; don’t be confused by scattering off the windows of the cell. If you cannot see the atoms flashing at all, ask your TA for help. The laser may need some realignment, or you may just not be doing something right.

Once you see fluorescence, compare the photodiode output to the rubidium spectrum shown in Figure 4. Make adjustments to the laser current and ramp amplitude in the ramp generator to get the spectrum as close as you can to the one shown in Fig. 4. Sometimes you may only get the laser to scan over part of this spectrum without mode hopping (see the laser primer). Record your best spectrum using the digital oscilloscope and print it out. At this point the laser is tuned to the rubidium lines. Before proceeding with the rest of the experiment, move the ND filter (attenuator) from its location in Figure 6 to a new position right in front of the photodiode. If you look closely you will see the absorption lines are still there, but much weaker. How come? There are two reasons. First, optical pumping is faster with more laser power, so the atoms are more quickly pumped to the dark state. That makes the absorption less. Second, the atoms become saturated with the high power, which also reduces the absorption.

### Obtaining a Saturated Absorption Spectrum.

The suggested set-up for observing saturated absorption spectra is shown in Figure 7. The laser should remain on resonance while you change the absorption set-up from Fig. 6 for saturated absorption. Note that the interferometer part is independent of the saturated absorption part and is already setup. You do not need to put it together. The optical isolator is a device that is used to prevent light from getting back to the diode laser, where it can adversely affect the frequency

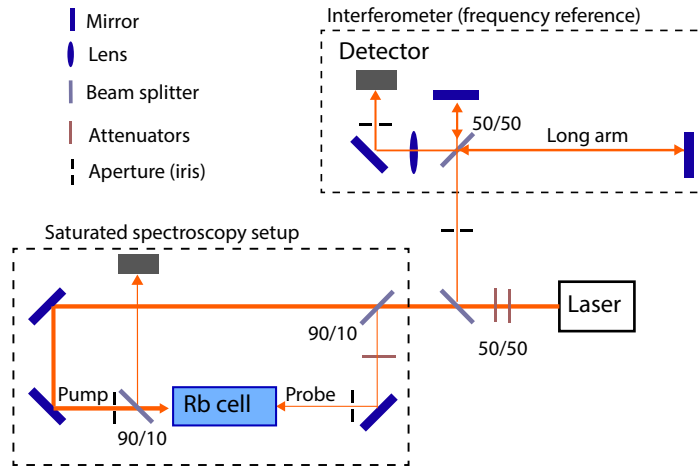

Figure 7: Recommended set-up to record rubidium saturated absorption spectra, and for measuring the hyperfine splittings.

stability. Note that the 10:90 beamsplitter puts most of the laser power into the pump beam. The irises are an alignment guide; if you have both the pump and probe beams going through small irises, then you can be assured that the beams overlap in the rubidium cell. If you block the pump beam you should get a spectrum that looks pretty much the same as you had in the previous section.

**Exercise 1.** Observe and record the best spectra you can for whatever rubidium lines you can see, especially the two strongest lines (87b and 85b in Figure 4). Obtain some spectra and put hard copies into your notebook. Note (but do not record) that the saturated absorption features go away if you block the pump beam, as expected.

**Measuring the Hyperfine Splitting.**

Complete the set-up in Figure 7 by adding the Michelson interferometer, which is already setup. (Turn off the laser frequency scanning while analyzing the interferometer, so the interference fringes are stable.) This interferometer provides a frequency reference and is used to calibrate the laser frequency scan. When you change the frequency of the laser, the position of the fringes will change, and this change is proportional to the arm-length difference of the two arms of the interferometer. The longer the long arm, the better your measurement will be. If you want you can add another mirror to the long arm to bounce it across the table, which is in a movable stage. Make sure that the interferometer is setup correctly. The beams should recombine in the beamsplitter and the output beams sent through a strong lens, so that the beam is expanded. The beams should overlap in position as well as angle, so that fringes are visible on the expanded beam with a large spacing. The photodiode should intersect only the light from one fringe of the interferometer. If you now scan the laser frequency you should observe temporal fringes on the photodiode output. The fringe spacing can be computed from the arm length difference, which you should measure.

When a beam travels a distance  $L$  it picks up a phase  $\phi = 2\pi L/\lambda$ , so the electric field becomes

$$E = E_0 e^{i\omega t} e^{i\phi}$$

When the beam is split in the interferometer, the two parts send down the two arms, and then recombined, the electric field is

$$E = E_{arm1} + E_{arm2} = E_0 e^{i\omega t} [e^{i4\pi L_1/\lambda} + e^{i4\pi L_2/\lambda}]$$

where  $L_1$  and  $L_2$  are the two arm lengths. Obtain the the intensity:

$$I \sim |E|^2 \sim 1 + \cos\left(\frac{4\pi\Delta L}{\lambda}\right)$$

where  $\Delta L = L_1 - L_2$ . If the laser frequency is constant, then the fringe pattern goes through one cycle every time the arm length changes by  $\lambda/2$ .

**Problem 1.** If  $\Delta L$  is fixed, how much does the laser frequency have to change to send  $I$  through one brightness cycle? For your known  $\Delta L$ , what is the fringe period in MHz? From this you can convert your measurement of  $\Delta L$  into a calibration of the laser frequency scan.

Use the oscilloscope to record the interferometer fringes and the saturated absorption spectra at the same time, as you scan the laser frequency. Watch that the interferometer fringes are uniform as a function of PZT voltage; if not the nonlinearities could compromise your calibration. Zoom in on the hyperfine features you want to measure. You will need to know which features belong to which lines, so identify the features by comparing your spectra with the level diagrams in Figures 4 and 5. Record the spectra and use the interferometer trace to calibrate the time scale in frequency. Check and discuss the linearity of the frequency sweep. Estimate your frequency calibration error. Use your calibration to measure the spacing of the various features in the spectra and determine by direct measurement the hyperfine splittings for both lines 87b and 85b in Figure 4. Estimate the measurement errors and compare it with the expected values.

**Exercise 2.** Estimate the largest  $P_{3/2}$  hyperfine splittings for 85Rb and 87Rb, in MHz. How accurate is is your measurement? What are the various uncertainties you encountered along the way?

### 3 References

- [1] Hansch, T. W., Schawlow, A. L., and Series, G. W. 1979, hThe Spectrum of Atomic Hydrogen,h Scientific American 240, 94 (March).
- [2] Cohen-Tannoudji, C., Dupont-Roc, J., and Grynberg, G. 1992, Atom-Photon Interactions, (Wiley).
- [3] Milonni, P., and Eberly, J. 1988, Lasers, (Wiley).
- [4] Schmidt, O., Knaak, K.-M., Wynands, R., and Meschede, D. 1994, "Cesium Saturation Spectroscopy Revisited: How to Reverse Peaks and Observe Narrow Resonances," Appl. Phys. B, 59, 167.