

Lecture 29

(Lorentz Contractions)

Physics 2310-01 Spring 2020

Douglas Fields

Reality...

- So, with the study of Special Relativity, comes a feeling of losing the idea of reality.
- Is there not a REAL time, or a REAL length, (or a real mass or a real momentum, as we're soon to find out).
- Well, what we can do is to define certain quantities VERY SPECIFICALLY, such that they are invariant to boosts between inertial frames, and then work with these quantities when we do any physics calculations.
- We have already done this with the Spacetime Interval – it is Lorentz invariant, so any frame will agree to its value.
- We also note that the Spacetime Interval is equal to the coordinate time of the inertial observer present at both events.
- For the remaining time spent studying Special Relativity, we are going to define other Lorentz invariant quantities for length, mass, energy and momentum which are Lorentz invariant and can therefore be used as meaningful physical quantities in our new reality.

Length

- We will define the length of an object in any inertial frame as the distance between any two simultaneous events in that frame that occur at its ends.
- Let's say we have a 80 ft long train, stationary at the station. In this frame, at $t=0$ ns, the front of the train is seen to be at $x=0$ ns (Event A), and the back of the train is seen (also at $t=0$) to be at $x=80$ ns (Event B).
- We say that the length of the train in this inertial reference frame is 80 ns.

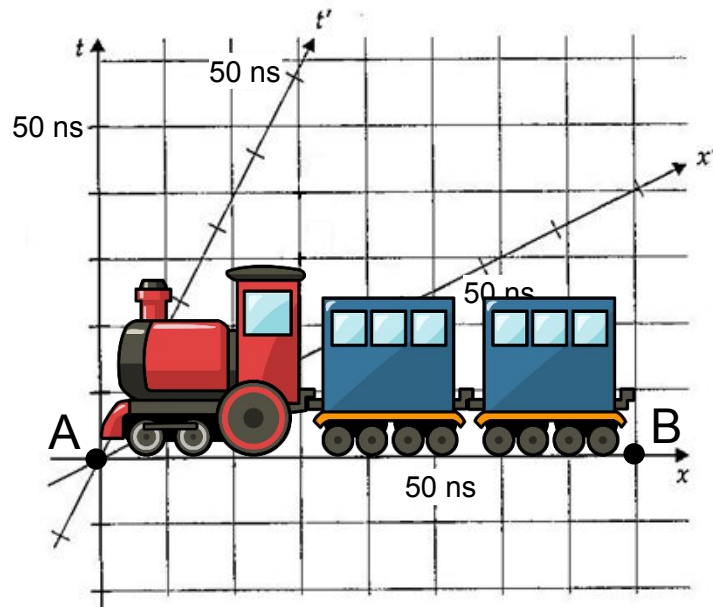

Length

- Now, let's look at the worldline of the front of the train and the rear of the train, and also the worldlines of every other segment (in x) of the train.
- Together, these will form a ***world region*** for the train – the shaded area in the spacetime diagram below.

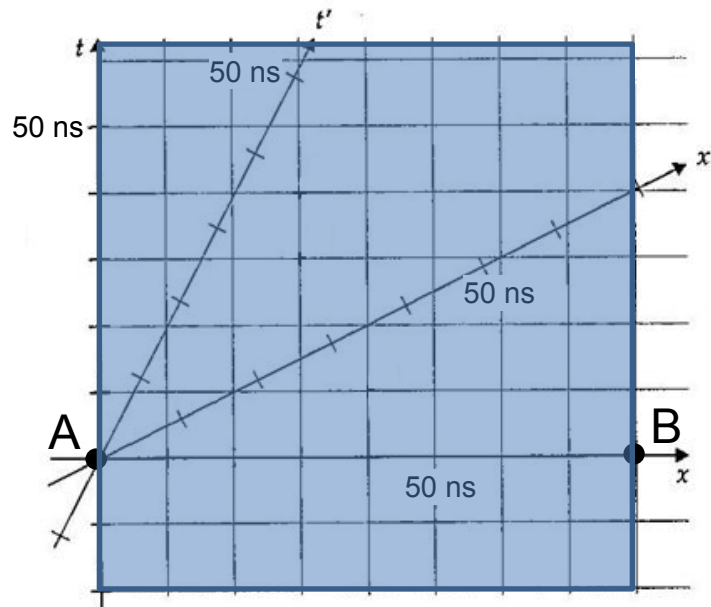

We define the length of an object in any inertial frame as the distance between any two simultaneous events in that frame that occur at its ends.

Length

- Now, let's say that we have another observer moving through the station at $\beta = 0.5$. In that observer's frame, **the two events that occur at the two ends of the stationary train and both occur at $t'=0$ ns**, the front of the train is seen to be at $x'=0$ ns (Event A), and the back of the train is seen (also at $t'=0$) to be at $x'=70$ ns (Event C).
- In this frame, the length of the stationary train is ~ 70 ns.

$$t = \gamma t',$$

where $\gamma = \frac{1}{\sqrt{1 - \beta^2}}$

$$= \frac{1}{\sqrt{1 - (0.5)^2}} = 1.15$$

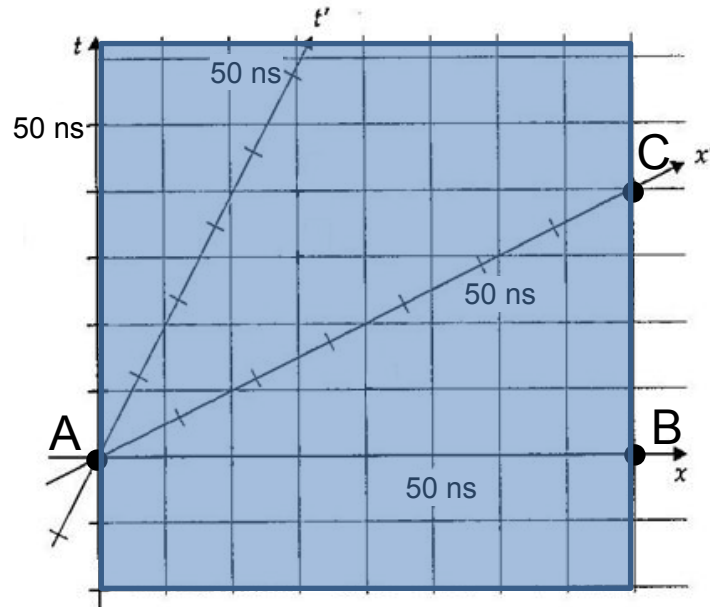

We define the length of an object in any inertial frame as the distance between any two simultaneous events in that frame that occur at its ends.

Length

- How do you show this using the Lorentz transformations?

$$\begin{aligned}x'_C &= \gamma(x_C - \beta t_C) \\ &= 1.15(80ns - 0.5 \cdot 40ns) \\ &= 1.15(60ns) = 69.3ns\end{aligned}$$

- But another way to calculate this which carries a bit more meaning, is by looking at our scale factors:

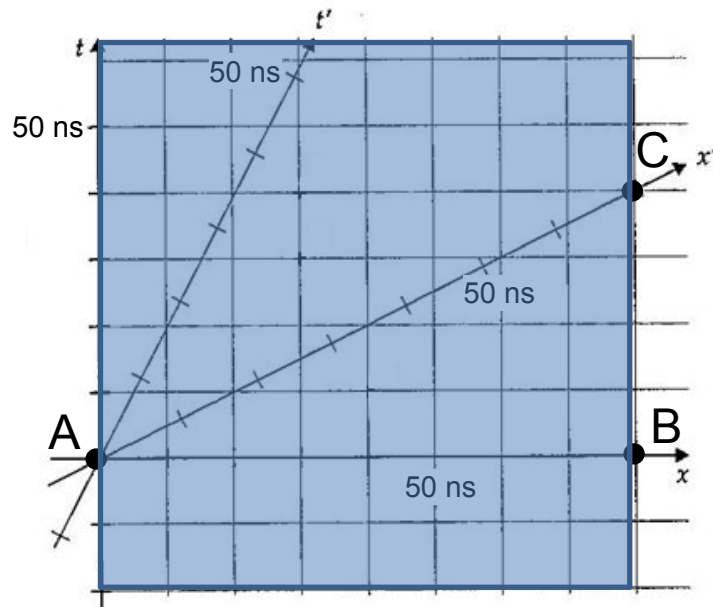

$$\begin{aligned}x'_C &= \frac{1}{\gamma} x_C \\ &= \frac{1}{1.15}(80ns) \\ &= 69.3ns\end{aligned}$$

We define the length of an object in any inertial frame as the distance between any two simultaneous events in that frame that occur at its ends.

Proper or Rest Length

- But what is the “real” length?
- The real length, or proper length, or **rest length** of an object is that which is measured in its own rest frame.
- So, in our case, the rest length of the train is 80 ns.
- In any frame moving relative to an object, its length is: $L = \frac{1}{\gamma} L_{\text{Rest}}$
- Just for fun, let’s get our train moving, and see what it looks like from the station frame...

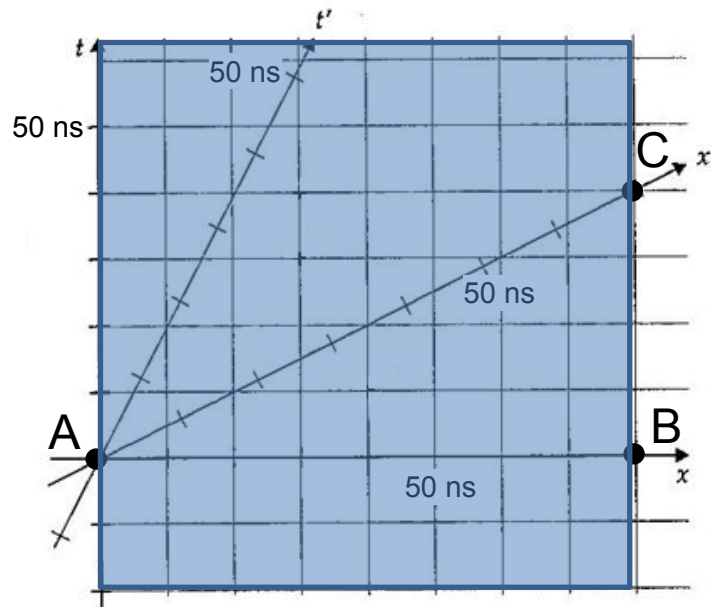

We define the length of an object in any inertial frame as the distance between any two simultaneous events in that frame that occur at its ends.

Rest Length

- The rest length of the train is 80 ns, now as measured in the train frame.
- In the station frame, its length is: $L = \frac{1}{\gamma} L_{\text{Rest}}$
- And we see that now, in the station frame, it is measured to be 69.3 ns.
- The Lorentz contraction is frame symmetric (as is time dilation).

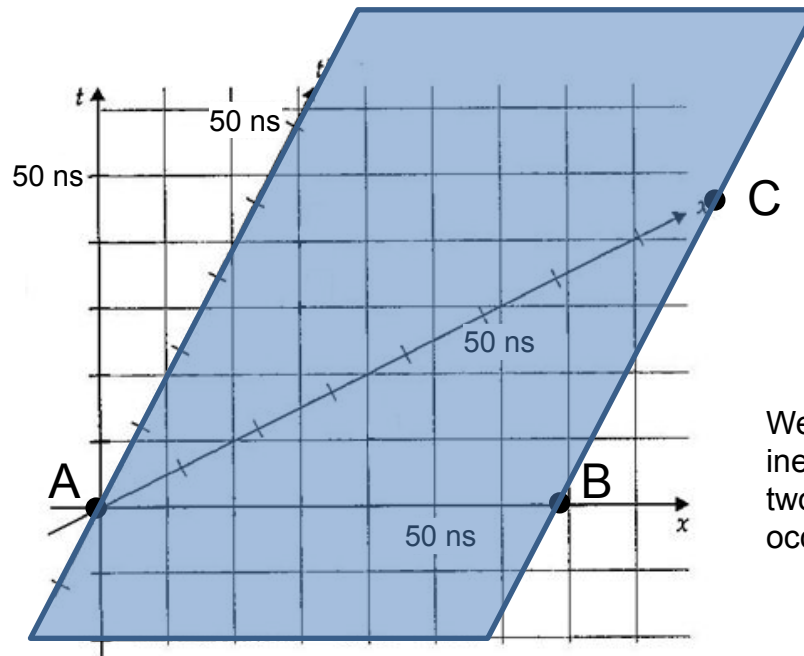

We define the length of an object in any inertial frame as the distance between any two simultaneous events in that frame that occur at its ends.

Lorentz Contraction

- So, did the train actually shrink???
- No, it is still 80 ns as measured in it's own frame!
- What is the reason for the apparent discrepancy between the two measurements?
- **Each frame contends that the other's clocks are not synchronized.**
- The station says that Events A and B occur at the same time, not events A and C.
- The train says that Events A and C are simultaneous, not events A and B!

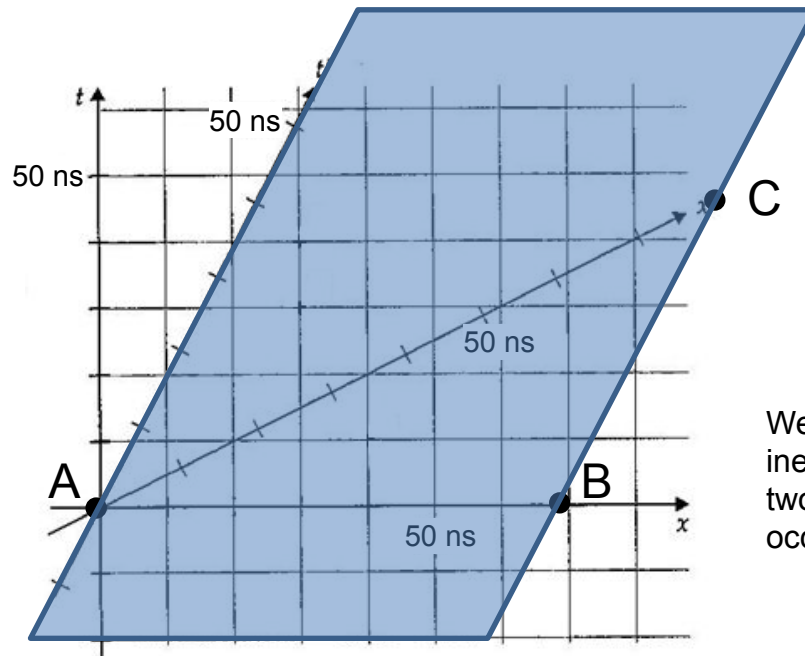

We define the length of an object in any inertial frame as the distance between any two simultaneous events in that frame that occur at its ends.

Pole and Barn Paradox

- OK, so I want to drive home the reason for Lorentz contraction (simultaneity is frame dependent) through a paradox – a false paradox.
- We are going to have two objects, and let's start out with them both at rest in a particular frame:
 - One is a 20 ns long pole.
 - The other is a 17.4 ns wide barn.
 - Both of these measurements are their respective rest lengths.
- Would the pole fit into the barn?
 - And yes, I mean horizontally.
 - And, no, don't worry about the thickness of the walls..
- Yes, and no.

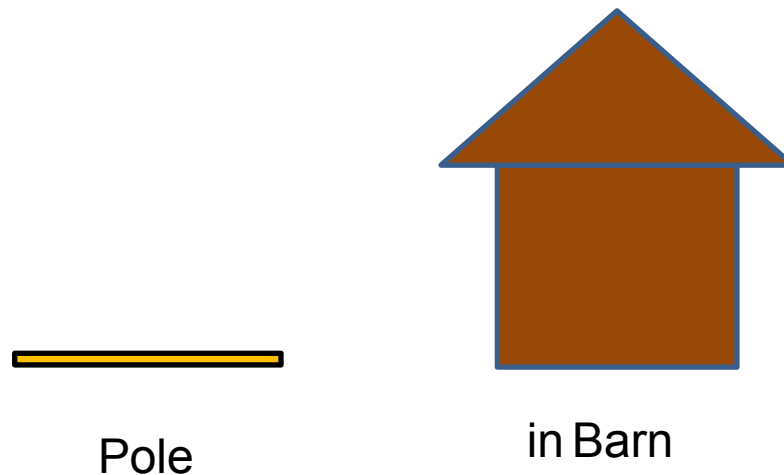

Pole and Barn Paradox

- Now we are going to have two observers, one in the barn, and one attached to the pole...
- And we are going to make the observer with the pole run towards the barn at speed 0.5.
- And ask, how does each observer answer the question: will the pole fit into the barn?

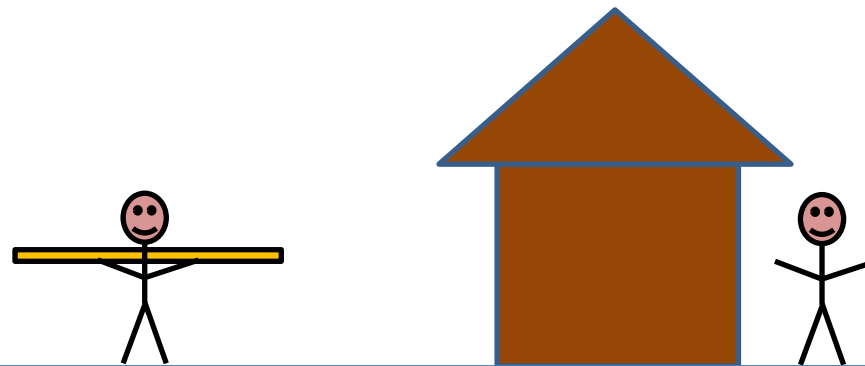

Pole, $L_R = 20\text{ns}$

Barn, $L_R = 17.4\text{ns}$

Pole and Barn Paradox

- Let's first look at the pole in the two-observer spacetime diagram.
- The home frame is that of the barn, the other frame is that of the pole.
- Notice that pole remains 20 ns in the frame of the pole, but in the frame of the barn, is now $20/1.15 = 17.4$ ns.
- So, does the pole fit in the barn?

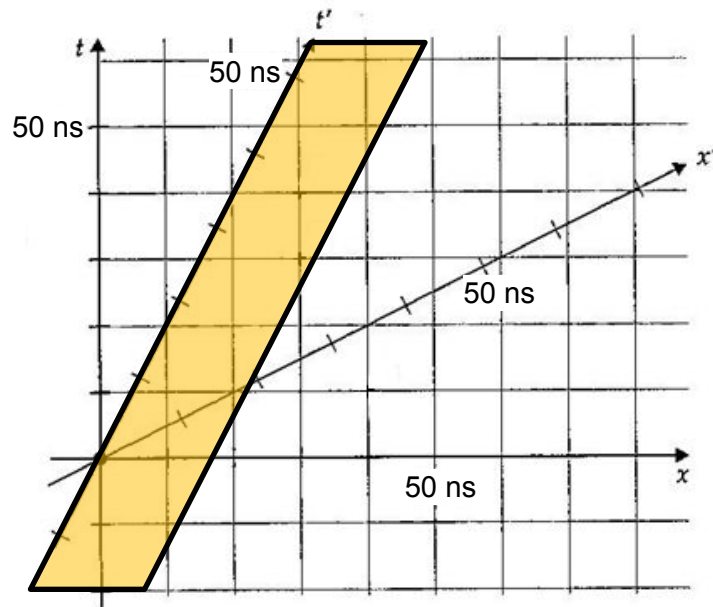

Pole and Barn Paradox

- Now let's look at the barn in the two-observer spacetime diagram.
- Again, the home frame is that of the barn, the other frame is that of the pole.
- Notice that barn remains 17.4 ns in the frame of the barn, but in the frame of the pole, is now $17.4/1.15 = 15.1$ ns.
- So, I ask again, does the pole fit in the barn, or not?

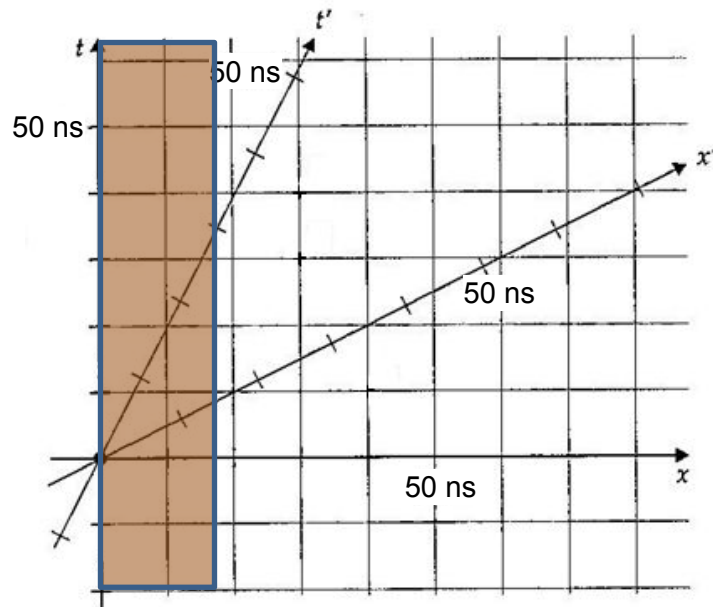

Pole and Barn Paradox

- When we put both world regions on the same graph we can see what each observers see:
 - Let the origin be when the back of the pole reaches the back of the barn.
 - The barn observer sees the pole and the barn as the same size, so that at the same time ($t=0$) both ends of the pole are at both ends of the barn!
 - The runner sees that the barn is narrower than the pole by about 4.9 ns, and so the pole is never entirely inside the barn.
 - In fact, the front of the pole reaches the front of the barn exactly 4.9 ns before the back of the pole reaches the back of the barn!

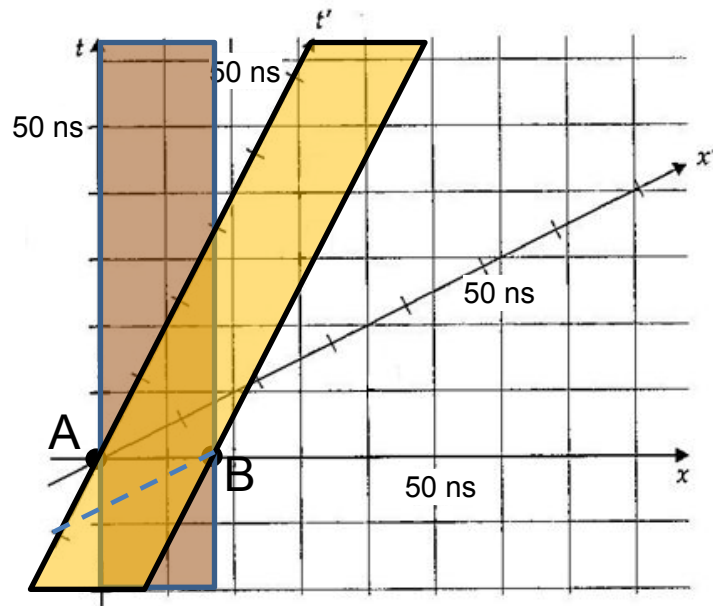

It's simultaneity, stupid!

- So, if the pole doesn't actually shrink, how does it fit in the barn???
- Although all the clocks in one reference frame are synchronized with each other, from the perspective of another reference frame, they aren't!
 - Events A and B occur at the same time in the reference frame of the barn, but not in the reference frame of the pole.
 - Events A and C occur at the same time in the reference frame of the pole, but not in the reference frame of the barn.

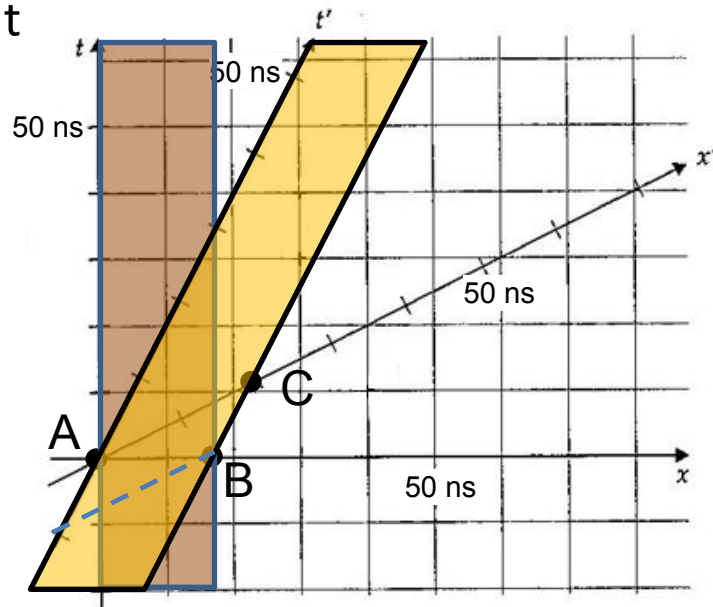

It's simultaneity, stupid!

- Try this way of thinking:
 - The left side (smaller x) of the barn is initially open, while the right side is initially closed.
 - When the pole is completely in the barn (according to the barn observer), the barn doors switch – open on the right, closed on the left.
 - How would you label those events?
 - When did they happen (in what order) according to the pole observer?
 - Is that important to relativity?

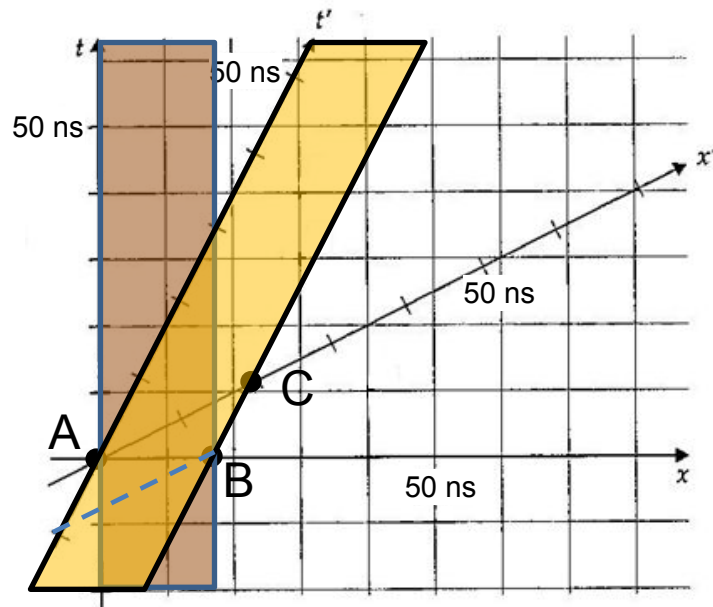

Causality

- So, the pole and barn paradox taught us that events that are simultaneous in one frame are not simultaneous in another.
- This brings up an interesting question.
- Let's say we have two events...
 - Event A is the pressing of a button that will cause an explosion 10 ns later at a location 50 ns away (Event B).
- Is it possible that these events can be drawn on our spacetime diagram?
- Of course we can draw the events!

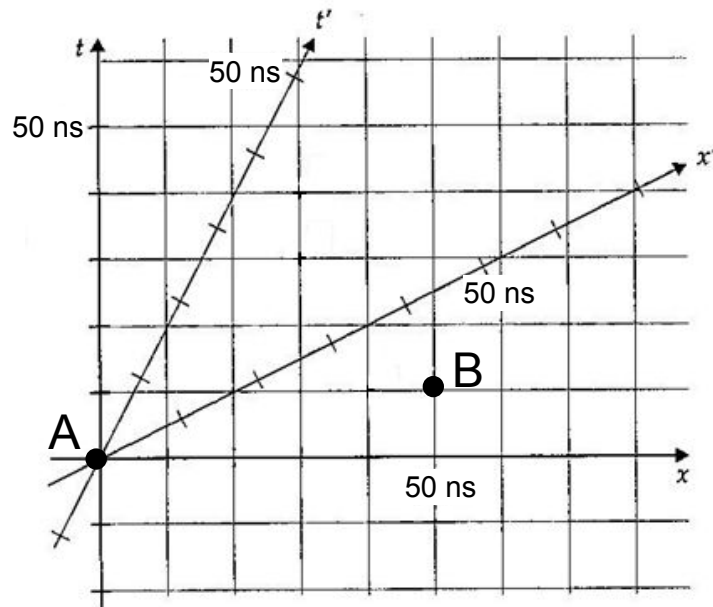

Causality

- But that doesn't mean that it makes any sense.
- Let's look at what these events look like in the frame of someone gliding by at speed 0.5.
- In that frame, the explosion takes place before the person presses the button – very strange indeed.
- In fact, for any two events which are separated in space more than they are separated in time there can be found an inertial frame in which the events change order in time...

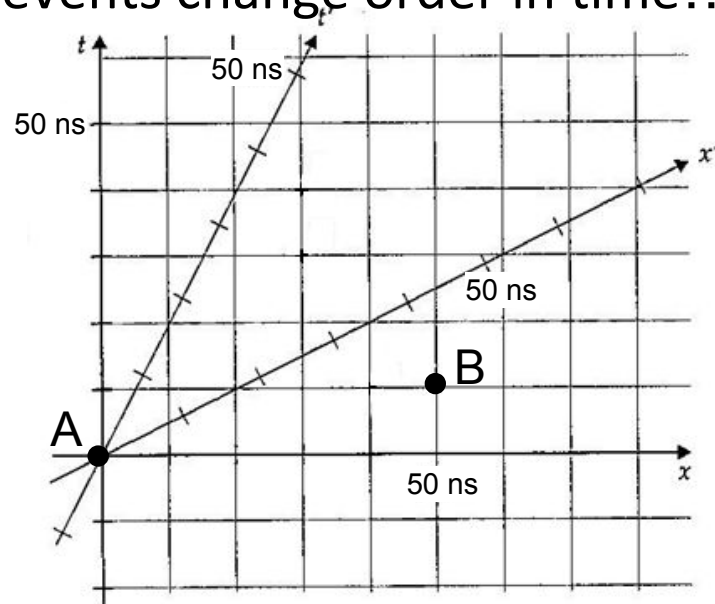

Spacetime Interval

- Let's examine the spacetime interval for these same two events:

$$\Delta s^2 = \Delta t^2 - \Delta d^2 = \Delta t^2 - \Delta x^2 - \cancel{\Delta y^2} - \cancel{\Delta z^2}$$

$$\Delta s^2 = (10ns)^2 - (50ns)^2 = -2400ns^2$$

- And we see that it is negative.
- Now, here I should clarify something that I may have misled you about:
- The spacetime interval is Δs^2 , not Δs .

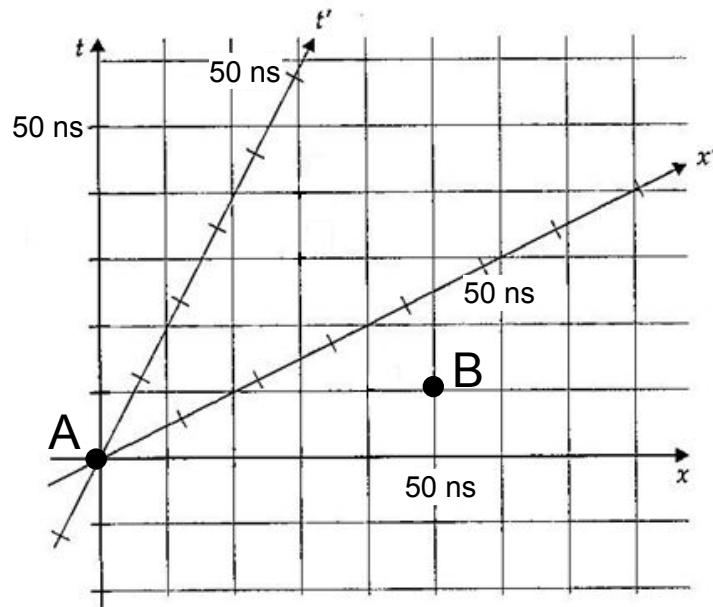

Spacetime Interval

- So, the spacetime interval, Δs^2 , can come in three “flavors”:
 - $\Delta s^2 > 0$
 - $\Delta s^2 = 0$
 - $\Delta s^2 < 0$
- Let’s look at these one at a time...

$$\Delta s^2 = \Delta t^2 - \Delta d^2$$

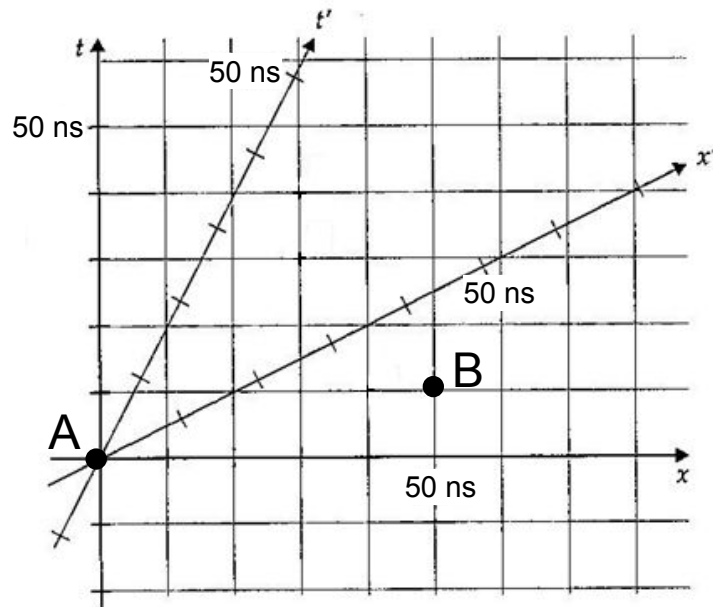

Spacetime Interval

- When the time component is larger than the distance component, then $\Delta s^2 > 0$, and there can be found an inertial reference frame such that both events occur at the same location (if we put one of them at the origin, then both are at $x'=0$), and **in this frame**:

$$\Delta s^2 = \Delta t'^2 - \Delta d'^2 \Rightarrow$$

$$\Delta t' = \sqrt{\Delta s^2}$$

- We refer to such pairs of events as time-like.

These events can be causally connected – Event A can cause Event B since in all possible inertial frames, Event A will precede Event B.

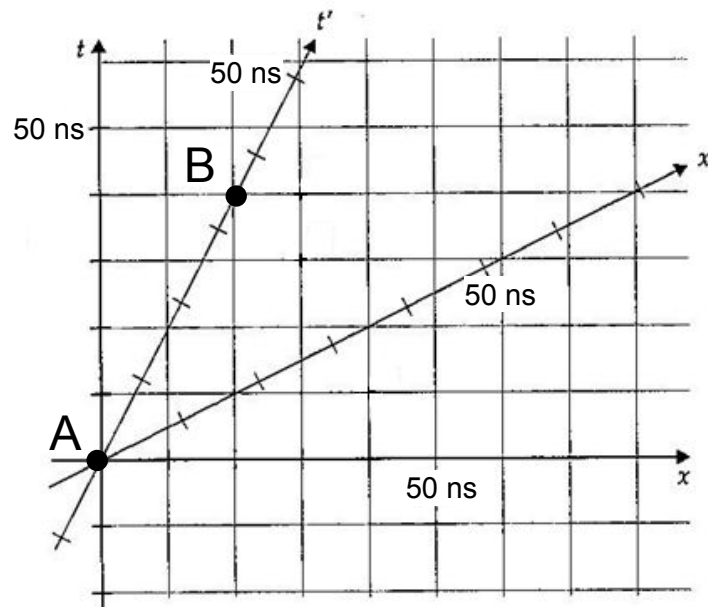

Spacetime Interval

- When the time component is equal to the distance component, then $\Delta s^2 = 0$.
- These pairs of events can only correspond to events associated with something travelling at the speed of light.
- We refer to such pairs of events as light-like.

These events can be causally connected only if Event A causes Event B through a light signal.

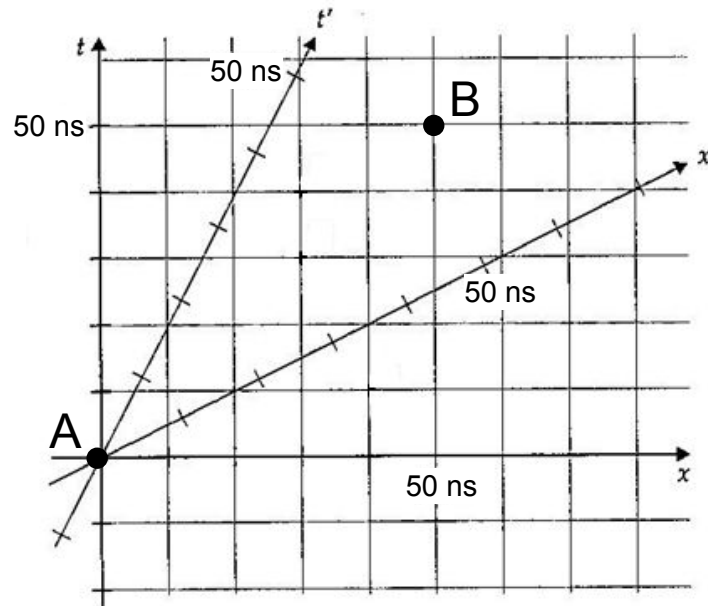

Spacetime Interval

- When the time component is smaller than the distance component, then $\Delta s^2 < 0$, and there can be found an inertial reference frame such that both events occur at the same time (if we put one of them at the origin, then both are at $t'=0$), and **in this frame**:

$$\Delta s^2 = \Delta t'^2 - \Delta d'^2 \Rightarrow$$

$$\Delta d' = \sqrt{|\Delta s^2|}$$

- We refer to such pairs of events as space-like.

These events cannot be causally connected – Event A cannot cause Event B since in different inertial frames, Event B could precede Event A.

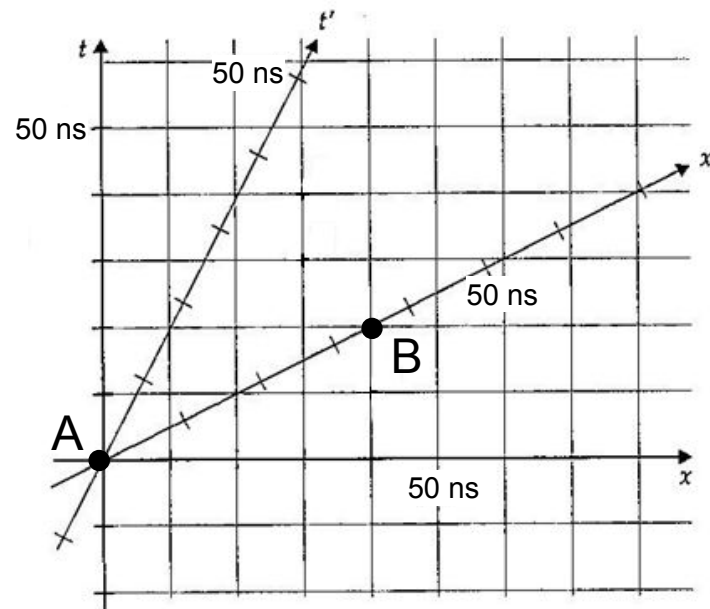

Back to Causality

- So, if we think of an observer (or event) at the origin of a spatially 2D spacetime diagram...
- Then every event that observer sees as happening to them (causing the event at the origin) in the past is contained in a cone whose surface is defined by the light world surface,
- And everything that observer (or event) can effect (cause) is contained in the light cone of the future.
- No events outside of those light cones can be causally connected to the origin.

